

62

Laryngoscopy

Bronchoscopy



MAHE International, Inc.

Made in Germany

CE / ISO 9001

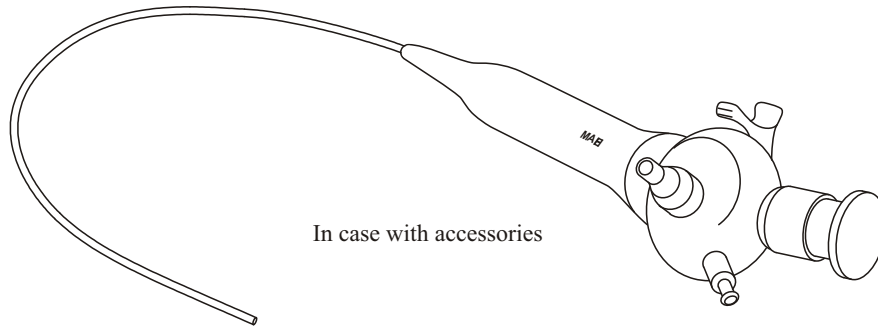

**Rhino-Laryngo-Pharyngo-Fiberscope
with fused silica image guide system,
ca. 2-3 μm pixel size**

62.000.05

Parameter / Technical data

- High resolution
- Excellent pushing characteristics
- More luminosity per surface area
- Working length max. 300 mm
- Diameter of working channel 3.1 mm
- 2-way tip-deflection 140°/140°
- Length of movable tip-section 30 mm
- Minimal bending radius 30 mm
- Viewing direction 0°
- Field of view 85°
- Depth of field 3 mm to infinity
- Cold Disinfection, ETO, Gas or Steris

**Rhino-Laryngo-Pharyngo-Fiberscope
with conventional image guide system,
6000 pixels, 10 μm -fibres**

62.000.10

Parameter / Technical data

- High-contrast image
- High flexibility
- Easy to focus
- Working length max. 300 mm
- Diameter of working channel 3.8 mm
- 2-way tip-deflection 160°/160°
- Length of movable tip-section 25 mm
- Minimal bending radius 30 mm
- Viewing direction 0°
- Field of view 100°
- Depth of field 3 mm to infinity
- Cold Disinfection, ETO, Gas or Steris



Micro Laryngoscopy



McIntosh

McIntosh laryngoscope blades, fiber optic

	Working length	
Fig. 0	55 mm	62.000.20
Fig. 1	70 mm	62.000.21
Fig. 2	90 mm	62.000.22
Fig. 3	110 mm	62.000.23
Fig. 4	130 mm	62.000.24
Fig. 5	150 mm	62.000.25



Miller

Miller laryngoscope blades, fiber optic

	Working length	
Fig. 0	55 mm	62.000.30
Fig. 1	80 mm	62.000.31
Fig. 2	130 mm	62.000.32
Fig. 3	170 mm	62.000.33
Fig. 4	180 mm	62.000.34



Wisconsin-Foregger

Wisconsin- Foregger laryngoscope blades, fiber optic

	Working length	
Fig. 0	55 mm	62.000.40
Fig. 1	70 mm	62.000.41
Fig. 2	90 mm	62.000.42
Fig. 3	110 mm	62.000.43
Fig. 4	135 mm	62.000.44



Xenon Handle, Ø 30 mm, knurled

62.000.51

Laryngoscope Holder and Chest Support for adults, 34 cm

62.001.05

Laryngoscope Holder and Chest Support for children, 24 cm

62.001.10

Ring 9.5 cm

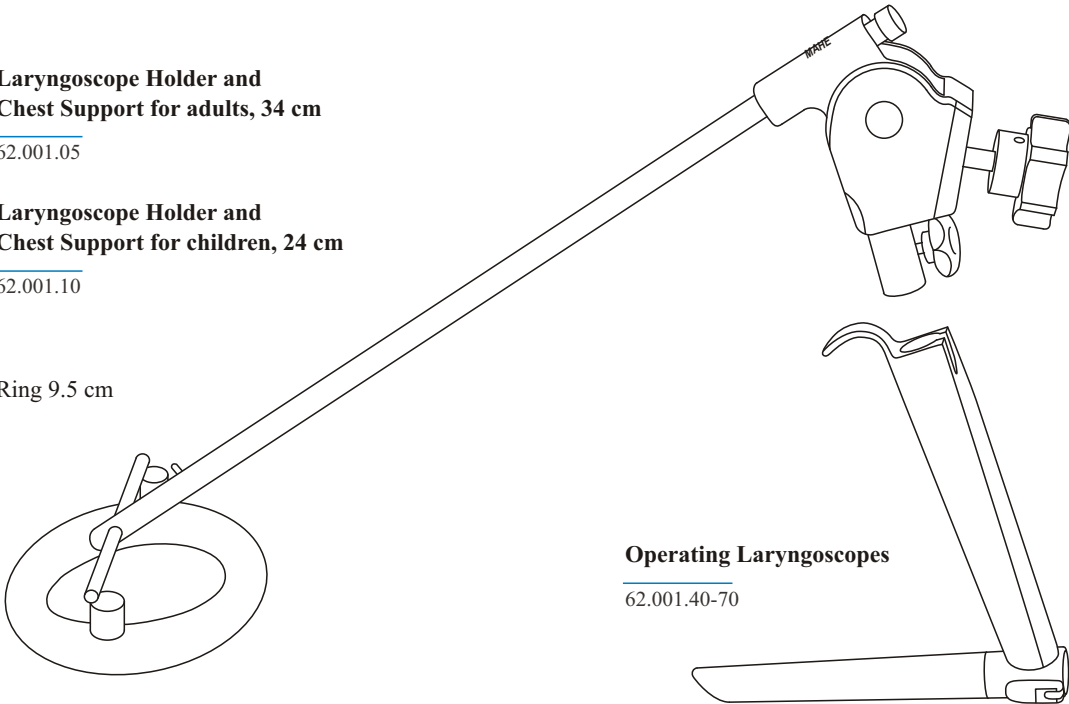

Operating Laryngoscopes

62.001.40-70



Fibre optic light carrier for Laryngoscope 62.001.65, 62.001.70

62.001.15



Fibre optic light carrier for Laryngoscope 62.001.40 - 62.001.55

62.001.20

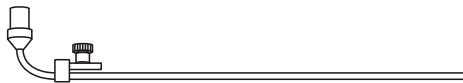

Fibre optic light carrier for Laryngoscope 62.001.60

62.001.25

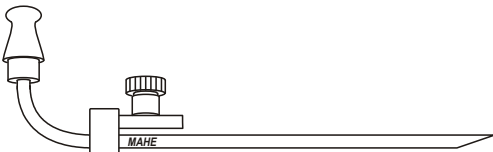

Injection drain tube for Laryngoscopes 62.001.40 - 62.001.70

62.001.30



Suction tube for Laryngoscopes 62.001.40 - 62.001.60

62.001.35

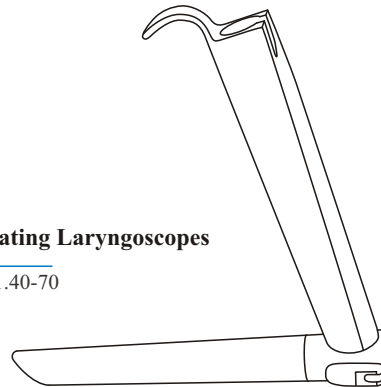

Operating Laryngoscopes

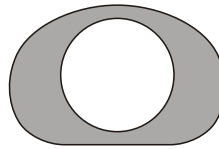

Length 18 cm, large, for adults
62.001.40

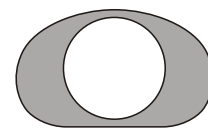

Length 18 cm, medium, most commonly used laryngoscope
62.001.45

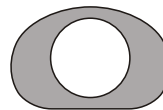

Length 18 cm, small, for difficult anatomical circumstances
62.001.50

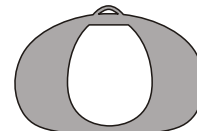

For anterior commissure
18 cm 62.001.55
22 cm 62.001.60

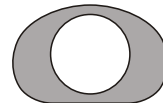

Length 15 cm, small, for children
62.001.65

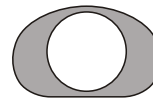

Length 13 cm, for small children
62.001.70



Micro Laryngoscopy

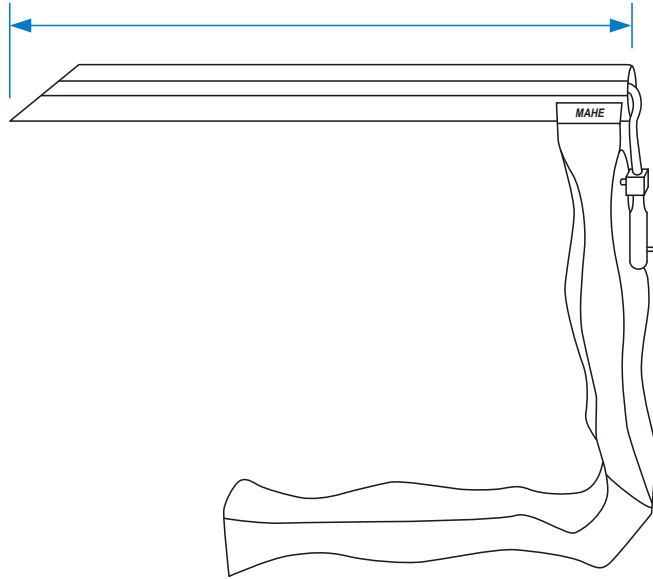

Jackson Laryngoscopes

For babies
120 mm 62.001.75

For children
170 mm 62.001.80

For adults
180 mm 62.001.85

Other lengths on request

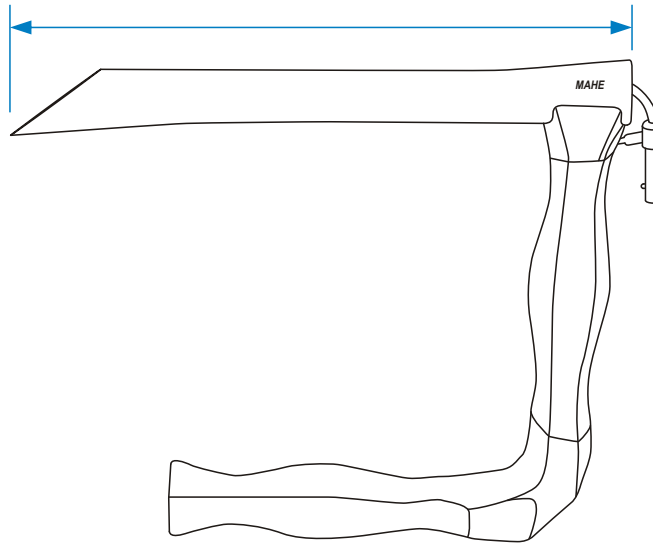

Holinger Laryngoscope

170 mm 62.001.90
180 mm 62.001.95

Other lengths on request

Stainless steel

MAHE International, Inc. 468 Craighead Street Nashville, TN 37204 USA

LARY-04

06/2006

Website: MahelInternational.com

Toll Free (800) 294-7946 Phone (615) 269-7256 Fax (615) 269-4605 Email info@MahelInternational.com

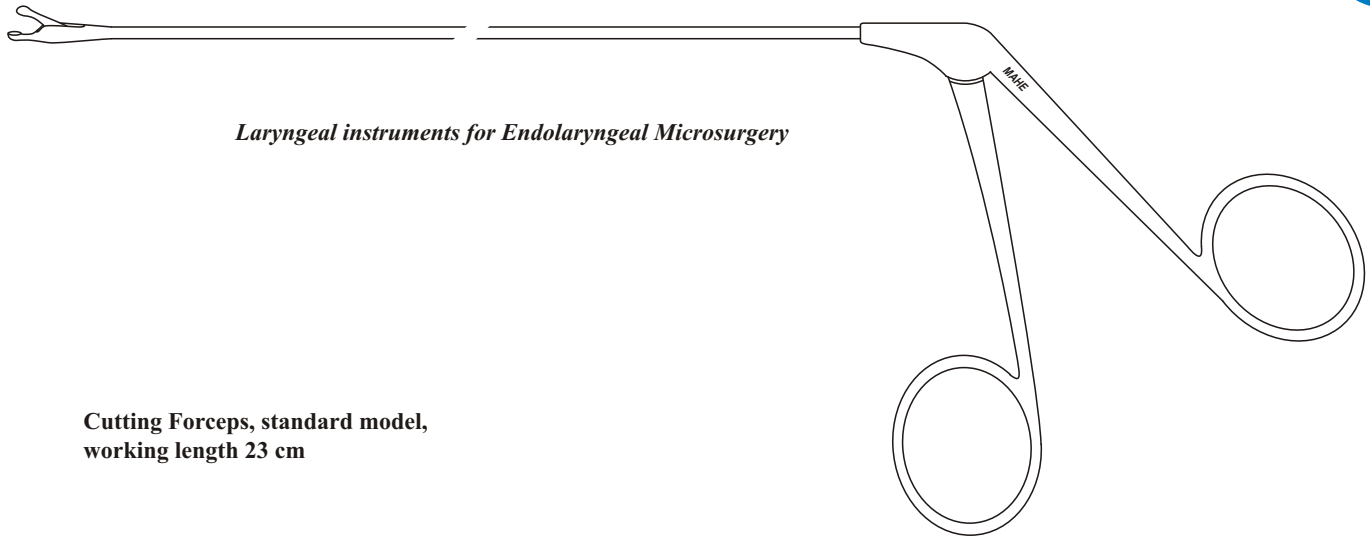



Laryngeal instruments for Endolaryngeal Microsurgery

**Cutting Forceps, standard model,
working length 23 cm**

	Straight	
	2 mm	62.002.05
	4 mm	62.002.10

	Curved upward	
	2 mm	62.002.15
	4 mm	62.002.20

	Curved right	
	2 mm	62.002.25
	4 mm	62.002.30

	Curved left	
	2 mm	62.002.35
	4 mm	62.002.40

	Curved upward right	
	2 mm	62.002.45

	Curved upward left	
	2 mm	62.002.55

	Horizontal opening, curved right	
	2 mm	62.002.65

	Horizontal opening, curved left	
	2 mm	62.002.75

**Alligator Forceps, standard model,
working length 23 cm**

	Straight, serrated	
		62.003.05

	Curved right	
		62.003.10

	Curved left	
		62.003.15

	Curved upward	
		62.003.20

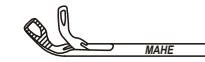
	With triangular jaws, curved upward right	
		62.003.25

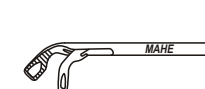
	With triangular jaws, curved upward left	
		62.003.30

	With triangular jaws, straight	
		62.003.35



Micro Laryngoscopy

Laryngeal instruments for Endolaryngeal Microsurgery

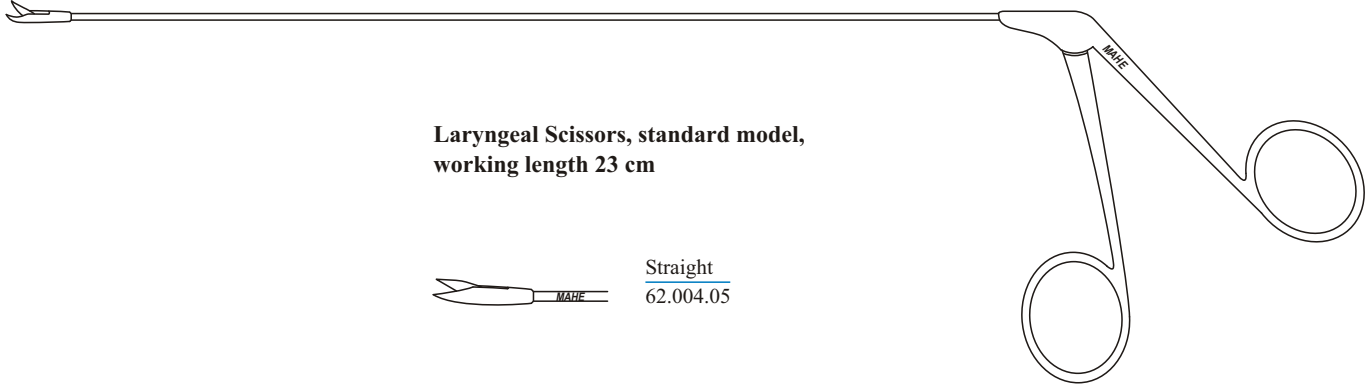

**Laryngeal Scissors, standard model,
working length 23 cm**

 Straight
62.004.05

 Angled
62.004.10

 Curved right
62.004.15

 Curved left
62.004.20

 Straight, horizontal cutting
62.004.25

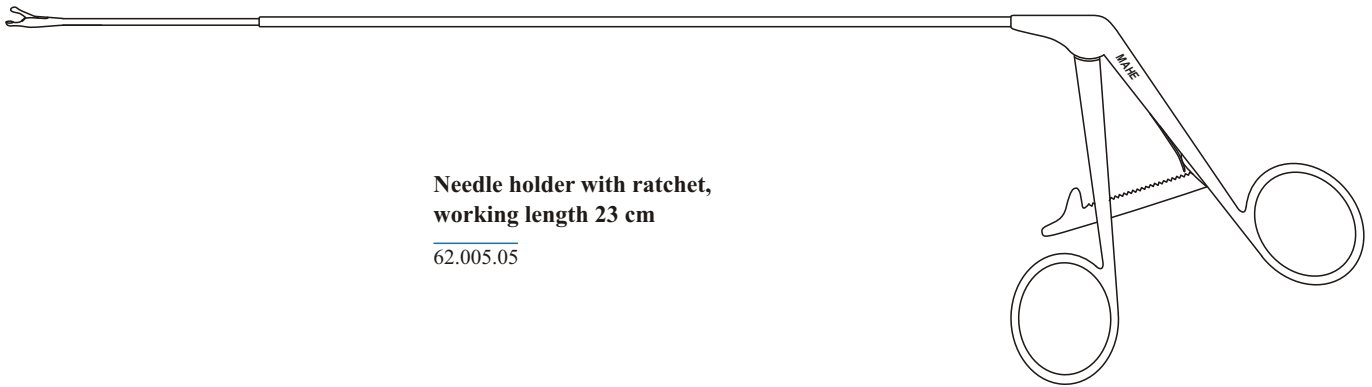

**Needle holder with ratchet,
working length 23 cm**

62.005.05

MAHE International, Inc. 468 Craighead Street Nashville, TN 37204 USA

LARY-06









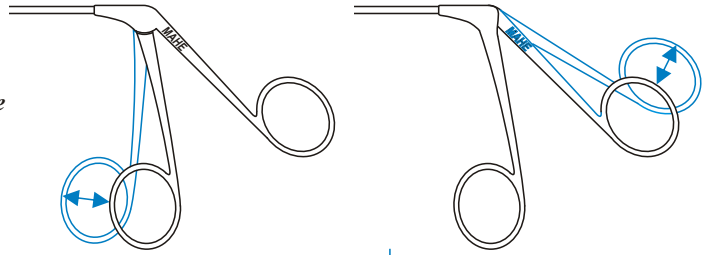





Website: MahelInternational.com

06/2006

Toll Free (800) 294-7946 Phone (615) 269-7256 Fax (615) 269-4605 Email info@MahelInternational.com

*Laryngeal instruments for Endolaryngeal
Microsurgery, working length 23 cm, very delicate*



Miniature Forceps with round 1mm cupped jaws			
	Straight	62.006.05	62.007.05
	Curved upward	62.006.10	62.007.10
	Curved right	62.006.15	62.007.15
	Curved left	62.006.20	62.007.20
	Curved upward right	62.006.25	62.007.25
	Curved upward left	62.006.30	62.007.30
Miniature Grasping Forceps, serrated			
	Straight	62.006.35	62.007.35
	Curved upward	62.006.40	62.007.40
	Curved right	62.006.45	62.007.45
	Curved left	62.006.50	62.007.50
Miniature Scissors			
	Straight	62.006.55	62.007.55
	Angled 45°	62.006.60	62.007.60
	Curved right	62.006.65	62.007.65
	Curved left	62.006.70	62.007.70



Micro Laryngoscopy

*Laryngeal instruments for Endolaryngeal Microsurgery,
angular for anterior commissure, working length 23 cm*

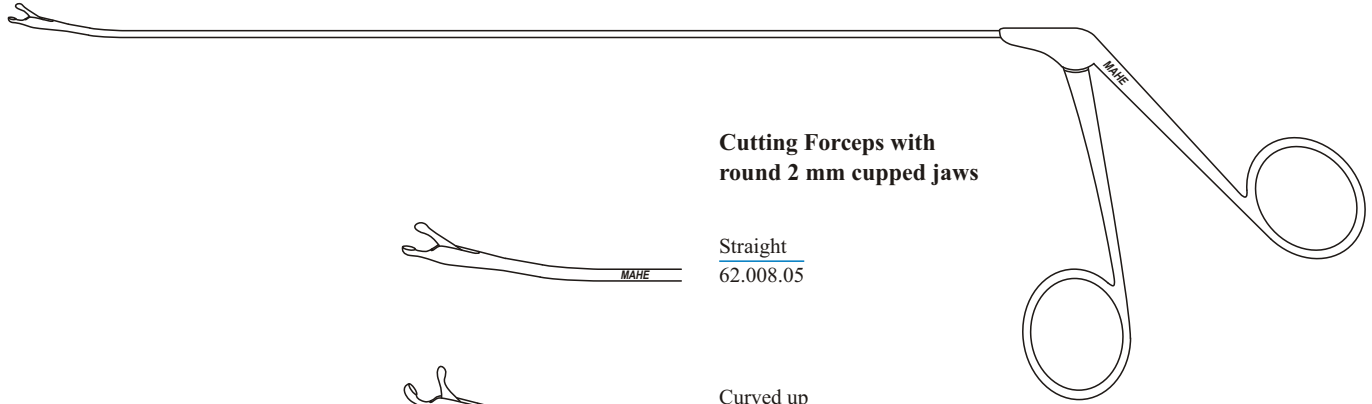

Cutting Forceps with round 2 mm cupped jaws



Straight
62.008.05



Curved up
62.008.10



Curved right
62.008.15



Curved left
62.008.20



Scissors straight
62.008.25

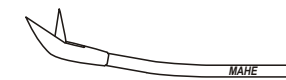

Scissors angled upward, 45°
62.008.30



Scissors curved right
62.008.35



Scissors curved left
62.008.40

MAHE International, Inc. 468 Craighead Street Nashville, TN 37204 USA

LARY-08

06/2006

Website: MahelInternational.com

Toll Free (800) 294-7946 Phone (615) 269-7256 Fax (615) 269-4605 Email info@MahelInternational.com

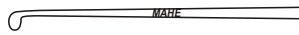
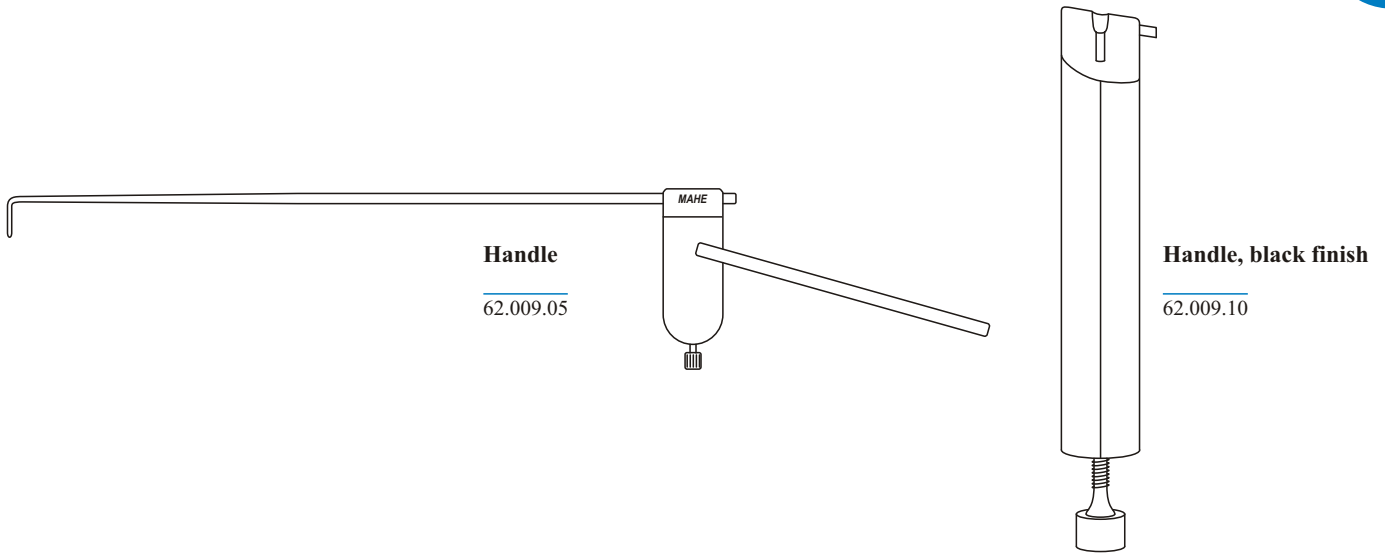

Knife, round, Ø 2.5 mm, 45° angled

62.009.15



Knife, round, vertical cutting

62.009.20



Knife, oval, straight

62.009.25



Knife, sickle shaped

62.009.30



Knife, golf stick shaped

62.009.35

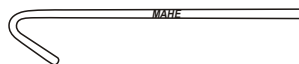

Hook, blunt

62.009.40



Hook, sharp

62.009.45

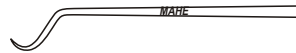

Needle, curved to right

62.009.50



Needle, curved to left

62.009.55



Elevator with suction channel

62.009.60



Knot tier

62.009.65



Hook with probe end, 90° angled

62.009.70



Micro Laryngoscopy

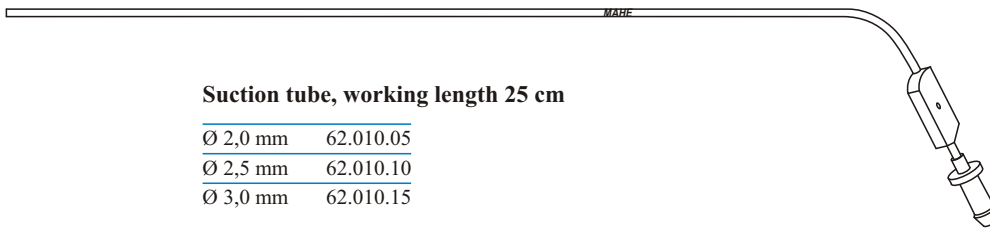

Suction tube, working length 25 cm

Ø 2,0 mm	62.010.05
Ø 2,5 mm	62.010.10
Ø 3,0 mm	62.010.15

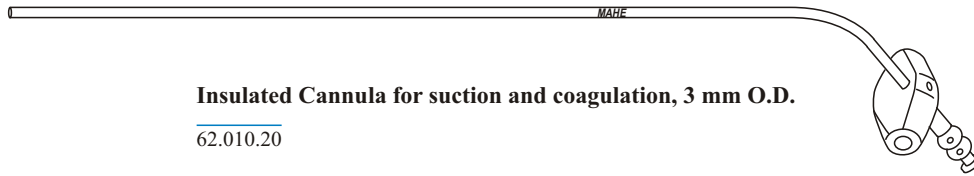

Insulated Cannula for suction and coagulation, 3 mm O.D.

62.010.20



Cotton carrier, twist end serrated, length 28 cm, Ø 2.5 mm

62.010.25

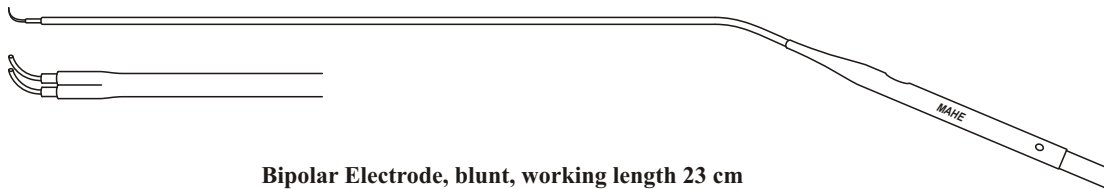

Bipolar Electrode, blunt, working length 23 cm

62.010.30

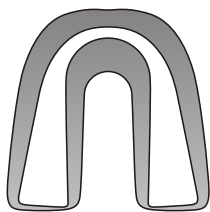

Teeth protector plastic

62.011.05

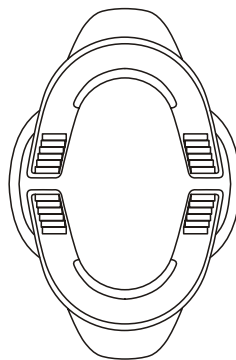

Endogard Teeth Protector, sterile

Package of 1 pair
62.011.10

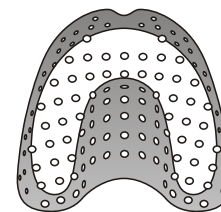

Teeth Protector, metal

Size 0 / children	62.011.15
Size 1	62.011.20
Size 2	62.011.25
Size 3	62.011.30

MAHE International, Inc. 468 Craighead Street Nashville, TN 37204 USA

Website: MahelInternational.com

LARY-10

06/2006

Toll Free (800) 294-7946 Phone (615) 269-7256 Fax (615) 269-4605 Email info@MahelInternational.com

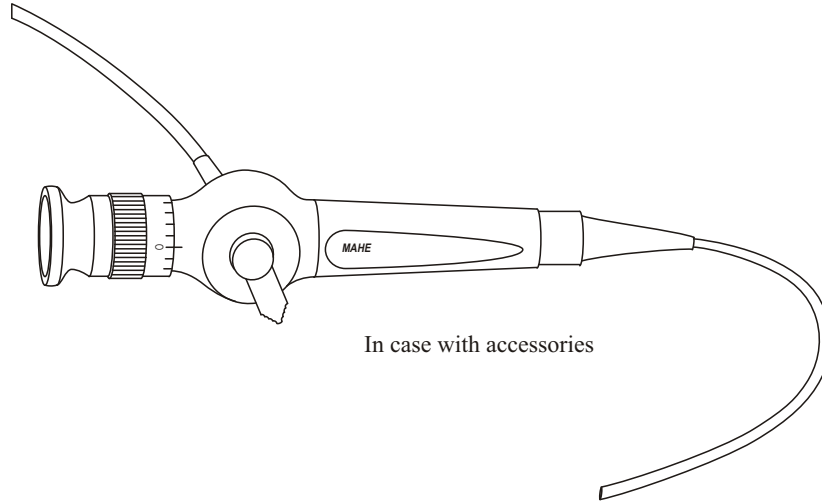

In case with accessories

Flexible Laryngo- /Bronchoscope with working channel

62.012.05

Parameter / Technical data

- | | |
|-------------------------------|---------------------------------|
| ● Working length | 550 mm |
| ● Working diameter | 5 mm |
| ● Diameter of working channel | 2.0 mm |
| ● 2-way tip-deflection | 130° / 180° |
| ● Viewing direction | 0° |
| ● Field of view | 100° |
| ● Eyepiece adaption | ACM / BS |
| ● Light guide adaption | ACM / BS + Adapter: Storz, Wolf |
| ● Glass image guide | |
| ● Brake for tip-deflection | |



Broncho Esophagosopes

Bronchoscopy telescopes

AUTOCLAVE
134° C / 273° F

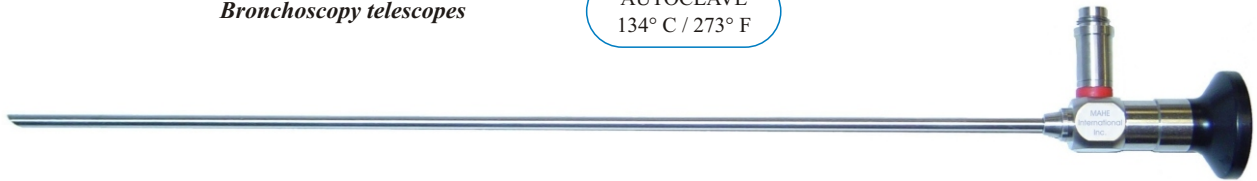

Bronchoscope, Ø 2.5 mm, WL 200 mm

Direction of view	
0°	62.100.00A
30°	62.100.30A
45°	62.100.45A

Bronchoscope, Ø 3.0 mm, WL 200 mm

Direction of view	
0°	62.101.00A
30°	62.101.30A
45°	62.101.45A

Bronchoscope, Ø 3.5 mm, WL 250 mm

Direction of view	
0°	62.102.00A
30°	62.102.30A
45°	62.102.45A

Bronchoscope, Ø 3.5 mm, WL 300 mm

Direction of view	
0°	62.103.00A
30°	62.103.30A
45°	62.103.45A

Bronchoscope, Ø 4.0 mm, WL 300 mm

Direction of view	
0°	62.104.00A
30°	62.104.30A
45°	62.104.45A

Bronchoscope, Ø 5 mm, WL 300 mm

Direction of view	
0°	62.105.00A
30°	62.105.30A
45°	62.105.45A

Bronchoscope, Ø 6 mm, WL 350 mm

Direction of view	
0°	62.106.00A
30°	62.106.30A
45°	62.106.45A

Bronchoscope, Ø 7 mm, WL 400 mm

Direction of view	
0°	62.107.00A
30°	62.107.30A
45°	62.107.45A

Bronchoscope, Ø 8 mm, WL 400 mm

Direction of view	
0°	62.108.00A
30°	62.108.30A
45°	62.108.45A

Bronchoscope, Ø 9.0 mm, WL 500 mm

Direction of view	
0°	62.109.00A
30°	62.109.30A
45°	62.109.45A

MAHE International, Inc. 468 Craighead Street Nashville, TN 37204 USA

Website: MahelInternational.com

BRO-02

06/2006

Toll Free (800) 294-7946 Phone (615) 269-7256 Fax (615) 269-4605 Email info@MahelInternational.com

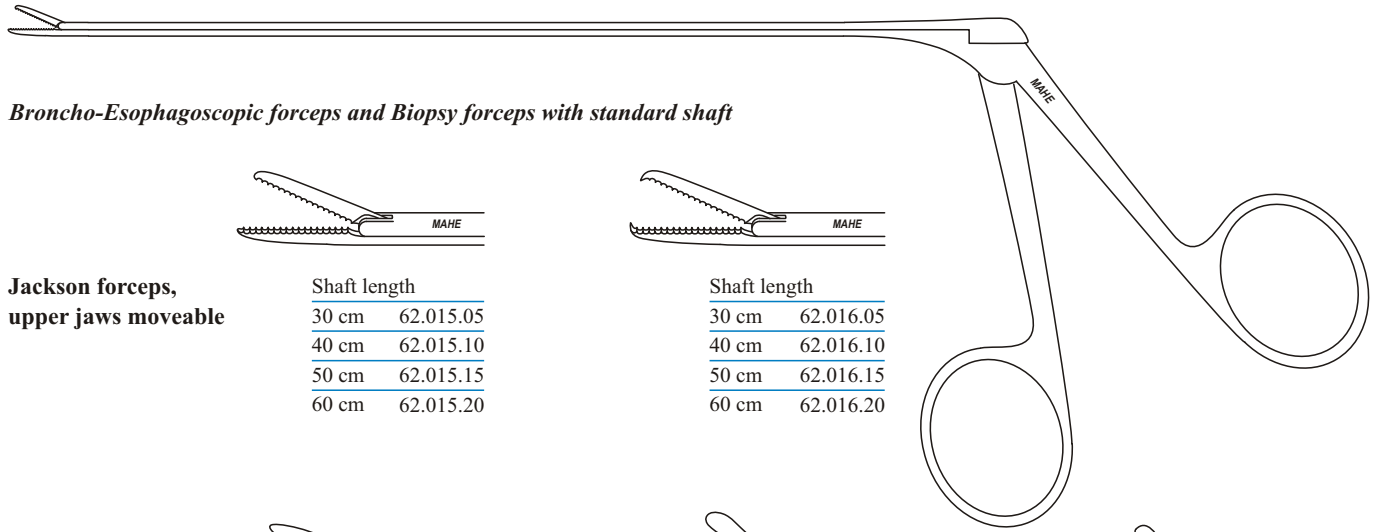

Broncho-Esophagoscopic forceps and Biopsy forceps with standard shaft

**Jackson forceps,
upper jaws moveable**



Shaft length	
30 cm	62.015.05
40 cm	62.015.10
50 cm	62.015.15
60 cm	62.015.20



Shaft length	
30 cm	62.016.05
40 cm	62.016.10
50 cm	62.016.15
60 cm	62.016.20



Shaft length	
30 cm	62.017.05
40 cm	62.017.10
50 cm	62.017.15
60 cm	62.017.20

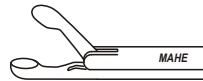

Shaft length	Ø 2 mm	Ø 4 mm
30 cm	62.018.05	62.018.50
40 cm	62.018.10	62.018.55
50 cm	62.018.20	62.018.60
60 cm	62.018.30	62.018.65

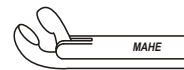

Shaft length	Ø 2 mm	Ø 4 mm
30 cm	62.019.05	62.019.50
40 cm	62.019.10	62.019.55
50 cm	62.019.20	62.019.60
60 cm	62.019.30	62.019.65

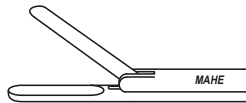

Shaft length	
30 cm	62.020.05
40 cm	62.020.10
50 cm	62.020.15
60 cm	62.020.20

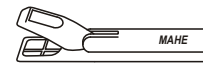

Shaft length	
30 cm	62.021.05
40 cm	62.021.10
50 cm	62.021.15
60 cm	62.021.20



Shaft length	
30 cm	62.022.05
40 cm	62.022.10
50 cm	62.022.15
60 cm	62.022.20

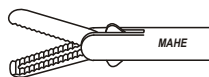

**Jackson forceps,
double action jaws**

Shaft length	
30 cm	62.023.05
40 cm	62.023.10
50 cm	62.023.15
60 cm	62.023.20

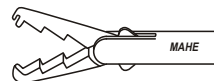

Shaft length	
30 cm	62.024.05
40 cm	62.024.10
50 cm	62.024.15
60 cm	62.024.20

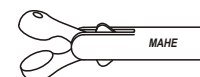

Shaft length	
30 cm	62.025.05
40 cm	62.025.10
50 cm	62.025.15
60 cm	62.025.20

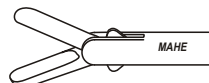

Shaft length	
30 cm	62.026.05
40 cm	62.026.10
50 cm	62.026.15
60 cm	62.026.20

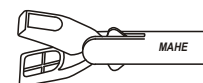

Shaft length	
30 cm	62.027.05
40 cm	62.027.10
50 cm	62.027.15
60 cm	62.027.20

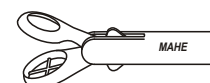

Shaft length	
30 cm	62.028.05
40 cm	62.028.10
50 cm	62.028.15
60 cm	62.028.20



Broncho Esophagoscopy

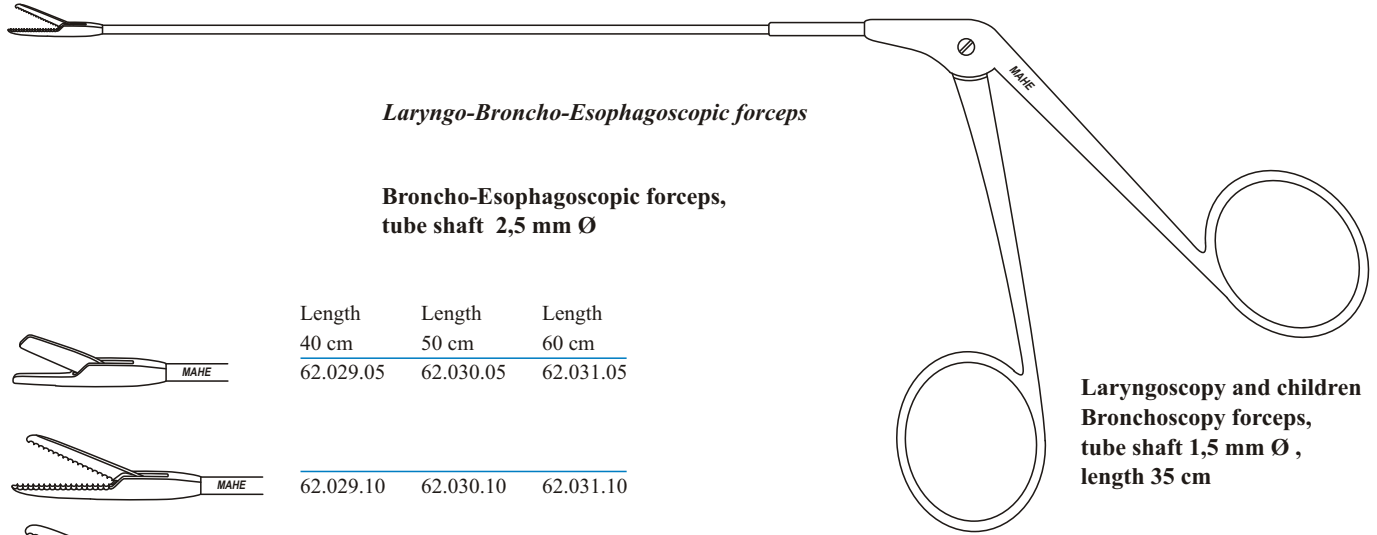

Laryngo-Broncho-Esophagoscopic forceps

**Broncho-Esophagoscopic forceps,
tube shaft 2,5 mm Ø**

**Laryngoscopy and children
Bronchoscopy forceps,
tube shaft 1,5 mm Ø ,
length 35 cm**

	Length 40 cm	Length 50 cm	Length 60 cm
	62.029.05	62.030.05	62.031.05
	62.029.10	62.030.10	62.031.10
	62.029.15	62.030.15	62.031.15
	62.029.20	62.030.20	62.031.20
	62.029.25	62.030.25	62.031.25
	62.029.30	62.030.30	62.031.30
	62.029.35	62.030.35	62.031.35
	62.029.40	62.030.40	62.031.40
	62.029.45	62.030.45	62.031.45
	62.029.50	62.030.50	62.031.50
	62.029.55	62.030.55	62.031.55
	62.029.60	62.030.60	62.031.60
	62.029.65	62.030.65	62.031.65

	62.032.05
	62.032.10
	62.032.15
	62.032.20
	62.032.25
	62.032.30
	62.032.35
	62.032.40
	62.032.45
	62.032.50
	62.032.55

MAHE International, Inc. 468 Craighead Street Nashville, TN 37204 USA

BRO-04

Website: MahelInternational.com

06/2006

Toll Free (800) 294-7946 Phone (615) 269-7256 Fax (615) 269-4605 Email info@MahelInternational.com

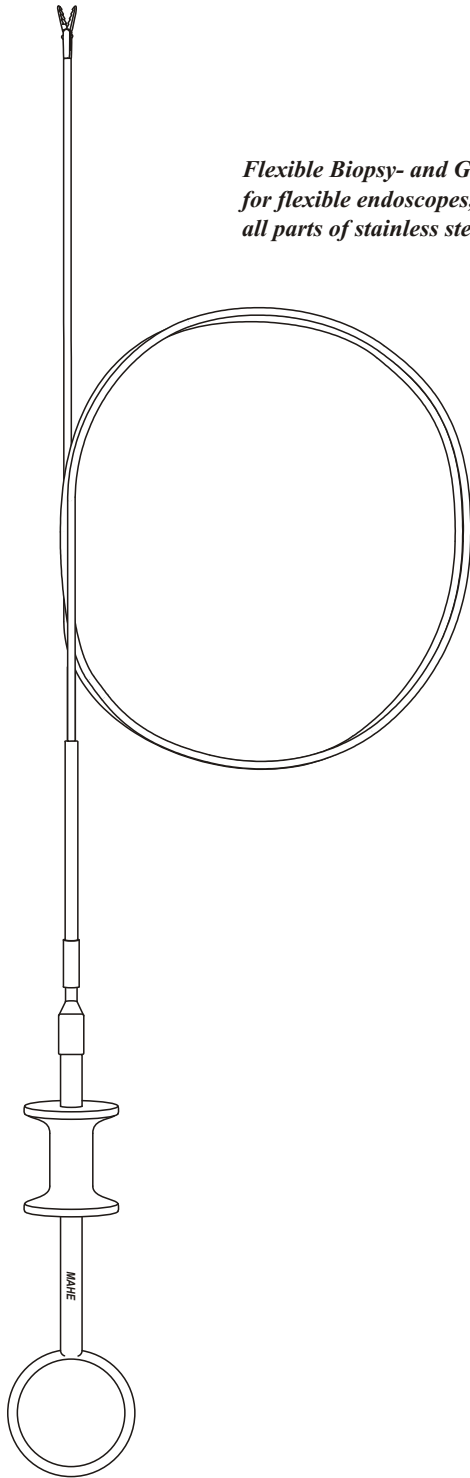

*Flexible Biopsy- and Grasping forceps,
for flexible endoscopes, double-action jaws,
all parts of stainless steel (except handle), totally autoclavable*



Flexible Biopsy- and Grasping forceps, round spoon

	Länge Length	Länge Length
	90 cm	120 cm
Ø 1,8 mm	62.013.05	62.013.10
Ø 2,3 mm	62.013.15	62.013.20

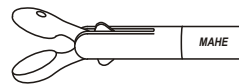

Flexible Biopsy- and Grasping forceps, oval spoon

	Länge Length	Länge Length
	90 cm	120 cm
Ø 1,8 mm	62.013.25	62.013.30
Ø 2,3 mm	62.013.35	62.013.40

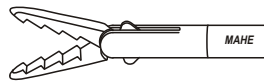

Flexible Biopsy- and Grasping forceps, alligator

	Länge Length	Länge Length
	90 cm	120 cm
Ø 1,8 mm	62.013.45	62.013.50
Ø 2,3 mm	62.013.55	62.013.60



Broncho Esophagoscopy

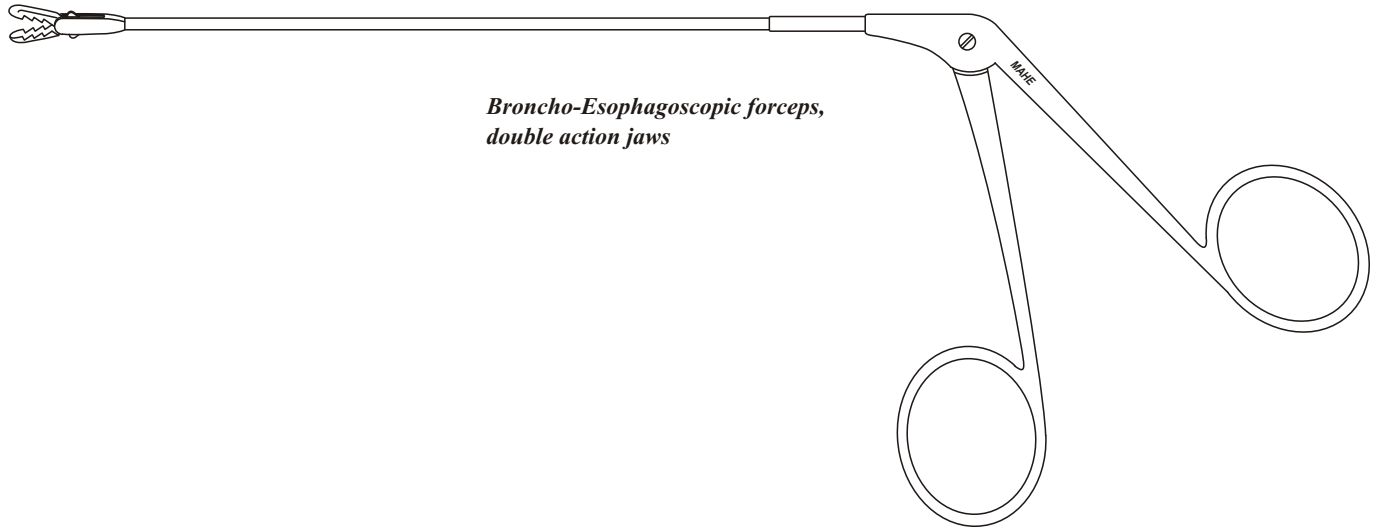

*Broncho-Esophagoscopic forceps,
double action jaws*

Foreign body forceps, alligator jaws

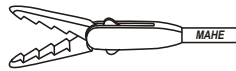

Working Length	Shaft Ø 1.5 mm	Shaft Ø 2,0 mm	Shaft Ø 2,5 mm
25 cm	62.033.05		
35 cm	62.033.10	62.033.25	
55 cm			62.033.45

Universal Biopsy and grasping forceps



Working Length	Shaft Ø 1.5 mm	Shaft Ø 2,0 mm	Shaft Ø 2,5 mm
25 cm	62.034.05		
35 cm	62.034.10	62.034.25	
55 cm			62.034.45

Biopsy forceps, spoon-shaped, straight



Working Length	Shaft Ø 1.5 mm	Shaft Ø 2,0 mm	Shaft Ø 2,5 mm
25 cm	62.035.05		
35 cm	62.035.10	62.035.25	
55 cm			62.035.45

Grasping forceps for peanuts

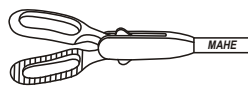

Working Length	Shaft Ø 1.5 mm	Shaft Ø 2,0 mm	Shaft Ø 2,5 mm
25 cm	62.036.05		
35 cm	62.036.10	62.036.25	
55 cm			62.036.45

MAHE International, Inc. 468 Craighead Street Nashville, TN 37204 USA

Website: MahelInternational.com

BRO-06

06/2006

Toll Free (800) 294-7946 Phone (615) 269-7256 Fax (615) 269-4605 Email info@MahelInternational.com

Accessories for Bronchoscopy

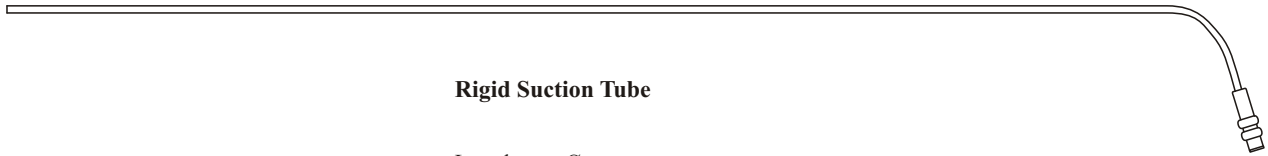

Rigid Suction Tube

Length	Ø	
35 cm	2,5 mm	62.037.05
50 cm	4,0 mm	62.037.10

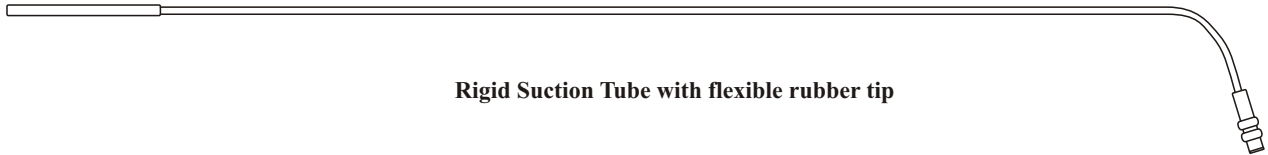

Rigid Suction Tube with flexible rubber tip

Length	Ø	
35 cm	2,5 mm	62.038.05
50 cm	4,0 mm	62.038.10



Cotton carrier

Working length	
35 cm	62.039.05
50 cm	62.039.10

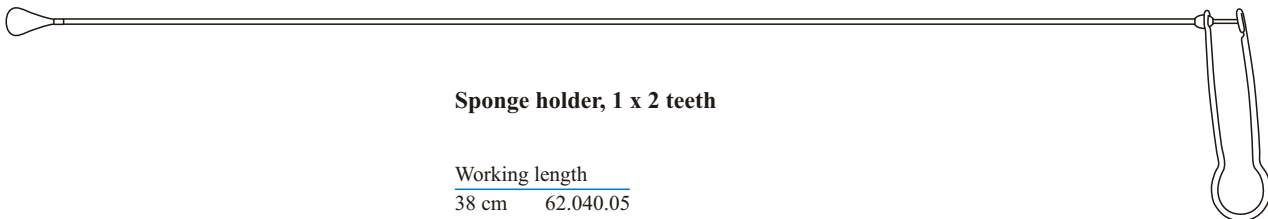

Sponge holder, 1 x 2 teeth

Working length	
38 cm	62.040.05